

# MaxMotion

## IEC PERFORMANCE DATA SHEET IEC Efficiency Level IE3

Catalog #: **IJC315L1-4-47**

| HP     | kW     | Voltage   | L.R. Amps | Efficiency | Power Factor | Service Factor | Frame | Design |
|--------|--------|-----------|-----------|------------|--------------|----------------|-------|--------|
| 200,00 | 149,20 | 460 / 796 | 1531,80   | 96,2%      | 0,88         | 1,15           | 315L  | N      |

| 60 Hz |     |     |        |     |        |     |       |          |
|-------|-----|-----|--------|-----|--------|-----|-------|----------|
| FLA   |     |     |        |     |        |     | Is/In | F.L. RPM |
| 208   | 230 | 333 | 460    | 575 | 796    | 990 |       |          |
| /     | /   | /   | 222,00 | /   | 128,00 | /   | 6,9   | 1785     |

| 50 Hz |        |        |        |        |        |            |       |          |
|-------|--------|--------|--------|--------|--------|------------|-------|----------|
| FLA   |        |        |        |        |        | Efficiency | Is/In | F.L. RPM |
| 190   | 380    | 400    | 415    | 660    | 725    |            |       |          |
| /     | 288,00 | 273,60 | 264,00 | 165,89 | 151,01 | 95,8%      | 6,9   | 1488     |

| Wgt. Lbs | PH | Duty | Insul. Class | Ambient Temp. | Elevation | Temp. Rise° C |
|----------|----|------|--------------|---------------|-----------|---------------|
| 2482,8   | 3  | S1   | H            | 40°C          | 1000 M    | 75            |

| % Efficiency |       | % Power Factor |      | Torque     |      |      | Protector Type | Winding Resist. Ω |
|--------------|-------|----------------|------|------------|------|------|----------------|-------------------|
| Full Load:   | 96,2% | Full Load:     | 0,88 | FLT ft.lbs | 60Hz | 50Hz |                |                   |
| 3/4 Load:    | 92,3% | 3/4 Load:      | 0,74 | LRT %      | 220  | 220  | PTC-150°C      | -                 |
| 1/2 Load:    | 83,8% | 1/2 Load:      | 0,57 | BDT %      | 220  | 220  |                |                   |

| Rotor Inertia Wk2 Lb-Ft2 | Max Load Inertia Wk2 Lb-Ft2 | Shaft Material | Frame Material | DE Bracket Type | ODE Bracket Type | Mounting | Enclosure | Protection |
|--------------------------|-----------------------------|----------------|----------------|-----------------|------------------|----------|-----------|------------|
| -                        | -                           | Standard       | Cast Iron      | Standard        | Standard         | B3       | TEFC      | IP55       |

| Ball Bearings |         | Grease          | Mount Type | Orientation | Cold Start (Secs) | Paint |
|---------------|---------|-----------------|------------|-------------|-------------------|-------|
| DE            | ODE     |                 |            |             |                   |       |
| NU319         | 6319-C3 | Mobil PolyRexEM | Rigid      | Horizontal  | 15                | Red   |

| Inverter Duty.<br>Motor meets MG1 parts 31.4.4.2 | Constant Torque Range | Variable Torque Range |
|--|-----------------------|-----------------------|
|  | 10:1                  | 20:1                  |

**WIRING CONNECTION DIAGRAM : E**

**IEC Frames 200L - 355L, Dual Voltage**  
460 / 796 VAC, 6 posts, 6 leads, Δ / Y Connection

Low Voltage (460 Vac)  
6 Leads Δ 6 posts

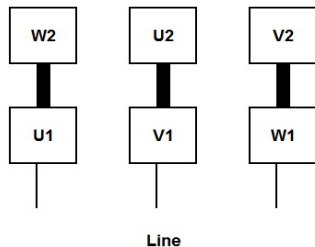

High Voltage (796 Vac)  
6 Leads Y 6 posts

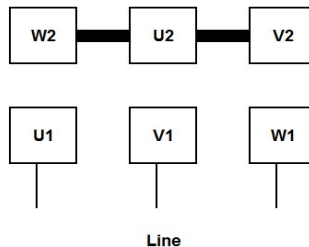

Date: **25 janvier, 2024**  
 Customer: \_\_\_\_\_  
 Contact: \_\_\_\_\_  
 Submittee: **J.C. Lavallée**

Catalogue #: **IJC315L1-4-47**

| IEC Efficiency Level IE3 |        |              |         |           |            |           |   |        |          |                  |               |
|--------------------------|--------|--------------|---------|-----------|------------|-----------|---|--------|----------|------------------|---------------|
| HP                       | Kw     | VAC          | RPM     | Enclosure | Frame      | Frequency | Design                                      | Poles  | LR Is/In | Insulation Class | Temp. Rise °C |
| 200,00                   | 149,20 | 460 / 796    | 1785    | TEFC      | 315L       | 60        | N   | 4      | 6,9      | H                | 75            |
|                          |        | 0Hz          | 6Hz     | 15Hz      | 30Hz       | 45Hz      | 60Hz  | 75Hz   | 90Hz     | 105Hz            | 120Hz         |
| Amps                     |        | 222,00       | 222,00  | 222,00    | 222,00     | 222,00    | 222,00                                      | 222,00 | 222,00   | 222,00           | 222,00        |
| RPM                      |        | 0            | 179     | 446       | 893        | 1339      | 1785  | 2231   | 2678     | 3124             | 3570          |
| Torq ft.lb               |        | 470,77       | 588,46  | 588,46    | 588,46     | 588,46    | 588,46                                      | 470,77 | 392,31   | 336,26           | 294,23        |
| Peak Tq ft.lb            |        | 617,88       | 1235,76 | 1235,76   | 1235,76    | 1235,76   | 1235,76                                     | 988,61 | 823,84   | 706,15           | 222,00        |
| HP                       |        | 0,00         | 20,00   | 50,00     | 100,00     | 150,00    | 200,00                                      | 200,00 | 200,00   | 200,00           | 200,00        |
|                          |        | Locked Rotor | Pull-Up | Breakdown | Rated Load | Idle      | Duty  | S. F.  | Ambient  | Elevation        | dBA @ 1M      |
| Speed (RPM)              |        | 0            | 810     | 1350      | 1785       | 1800      | S1  | 1,15   | 40°C     | 3,300 ft         | -             |
| Current (Amps)           |        | 1531,80      | 1225,44 | 857,81    | 222,00     | 179,31    | <b>VFD Rating: Meets MG1 parts 31.4.4.2</b> |        |          |                  |               |
| Torque (ft-lbs)          |        | 1294,61      | 1100,42 | 1294,61   | 588,46     | 0,0       | CT :  | 10:1   | VT :     | 20:1             |               |

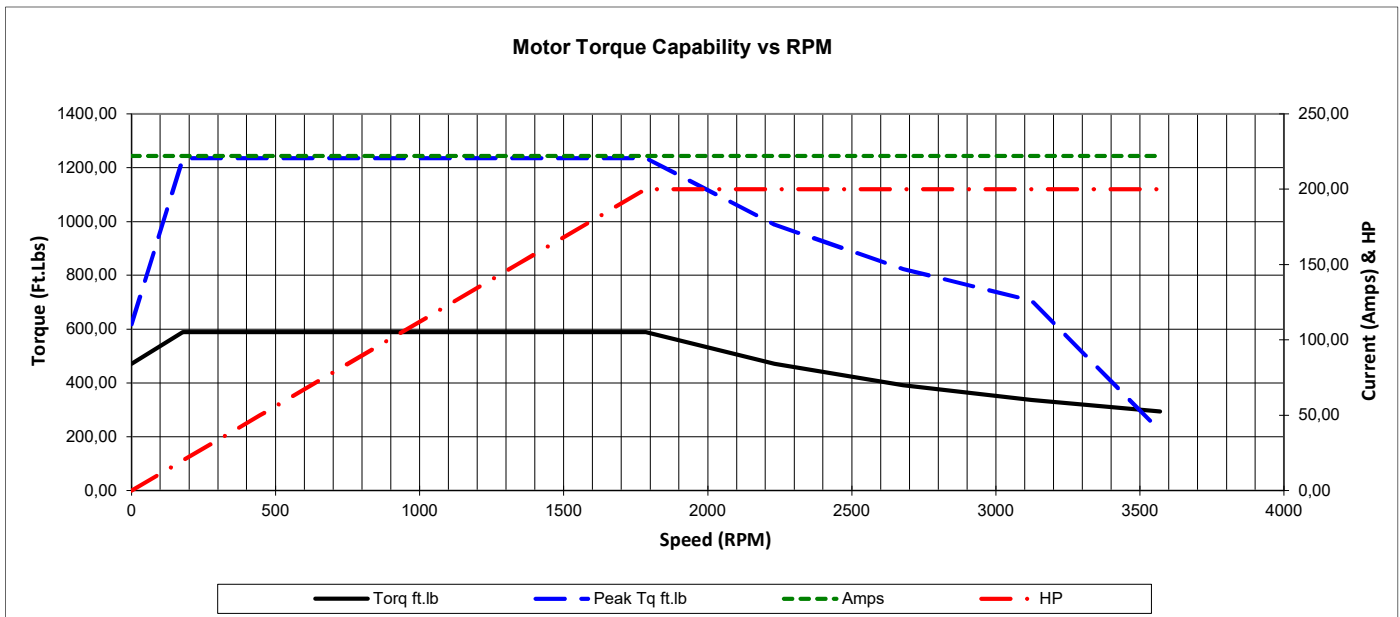
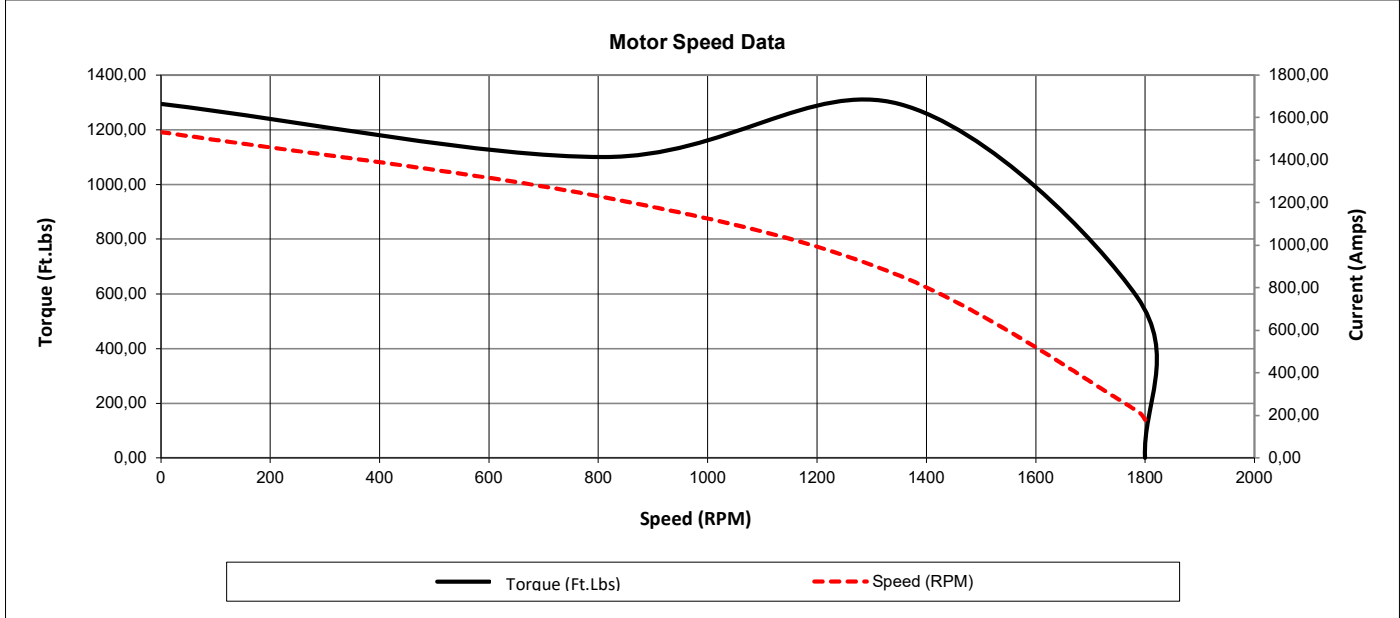

Date: **25 janvier, 2024**  
 Customer: \_\_\_\_\_  
 Contact: \_\_\_\_\_  
 Submittee: **J.C. Lavallée**

Catalogue #: **IJC315L1-4-47**

| IEC Efficiency Level IE3 |        |           |      |           |       |           |        |       |          |                  |               |
|--------------------------|--------|-----------|------|-----------|-------|-----------|--------|-------|----------|------------------|---------------|
| HP                       | Kw     | VAC       | RPM  | Enclosure | Frame | Frequency | Design | Poles | LR Is/In | Insulation Class | Temp. Rise °C |
| 200,00                   | 149,20 | 460 / 796 | 1785 | TEFC      | 315L  | 60        | N      | 4     | 6,9      | H                | 75            |

| Load %      | 0%     | 25%    | 50%    | 75%    | 100%   | 125%   | 150%   |
|-------------|--------|--------|--------|--------|--------|--------|--------|
| Amps        | 179,31 | 179,31 | 196,38 | 204,92 | 222,00 | 256,15 | 324,46 |
| Torq ft/lbs | 0      | 146,19 | 293,00 | 440,42 | 588,46 | 767,02 | 985,14 |
| RPM         | 0      | 1796   | 1793   | 1789   | 1785   | 1712   | 1599   |
| Eff %       | 0      | 62,7   | 83,8   | 92,3   | 96,2   | 93,7   | 86,1   |
| PF %        | 0      | 40,2   | 57,0   | 74,4   | 88,0   | 90,6   | 92,4   |

|                 | Locked Rotor | Pull-Up | Breakdown | Rated Load | Idle   | Duty  | S. F. | Ambient | Elevation | dBA @ 1M |
|-----------------|--------------|---------|-----------|------------|--------|---|-------|---------|-----------|----------|
| Speed (RPM)     | 0            | 810     | 1350      | 1785       | 1800   | S1  | 1,15  | 40°C    | 3,300 ft  | -        |
| Current (Amps)  | 1531,80      | 1225,44 | 857,81    | 222,00     | 179,31 | <b>VFD Rating: Meets MG1 parts 31.4.4.2</b> |       |         |           |          |
| Torque (ft-lbs) | 1294,61      | 1100,42 | 1294,61   | 588,46     | 0,0    | CT :  | 10:1  | VT :    | 20:1      |          |

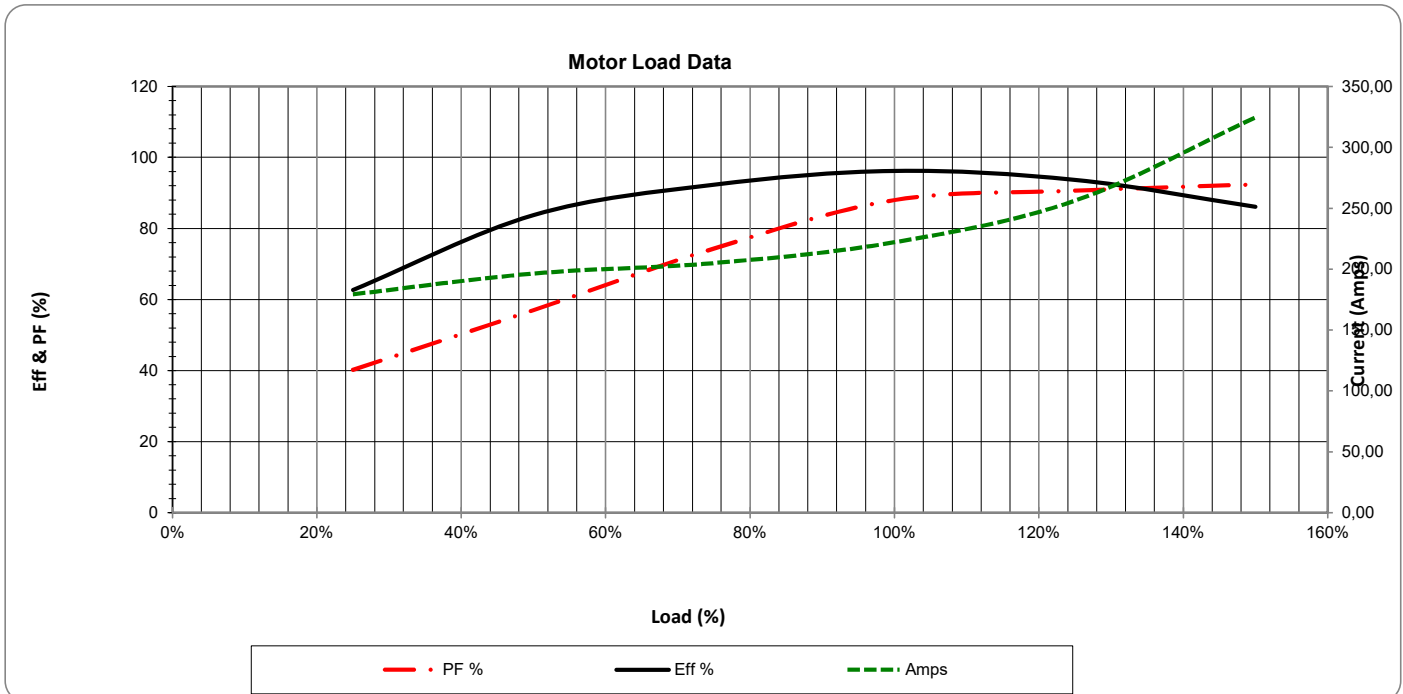
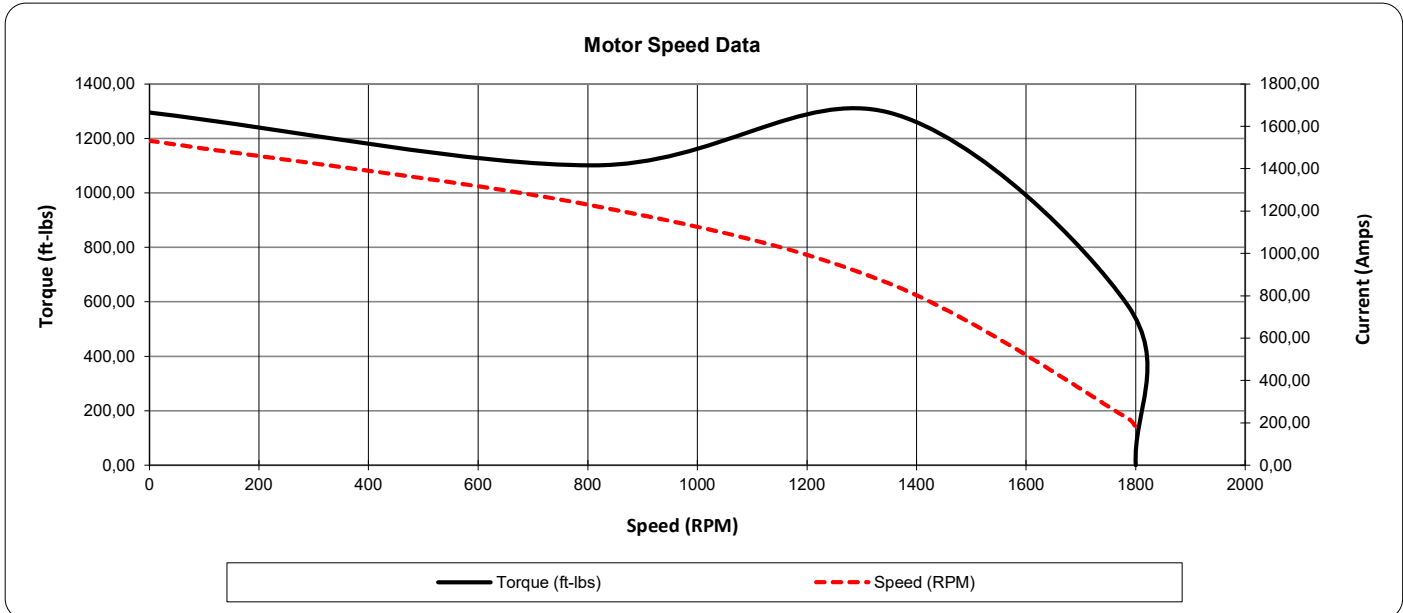





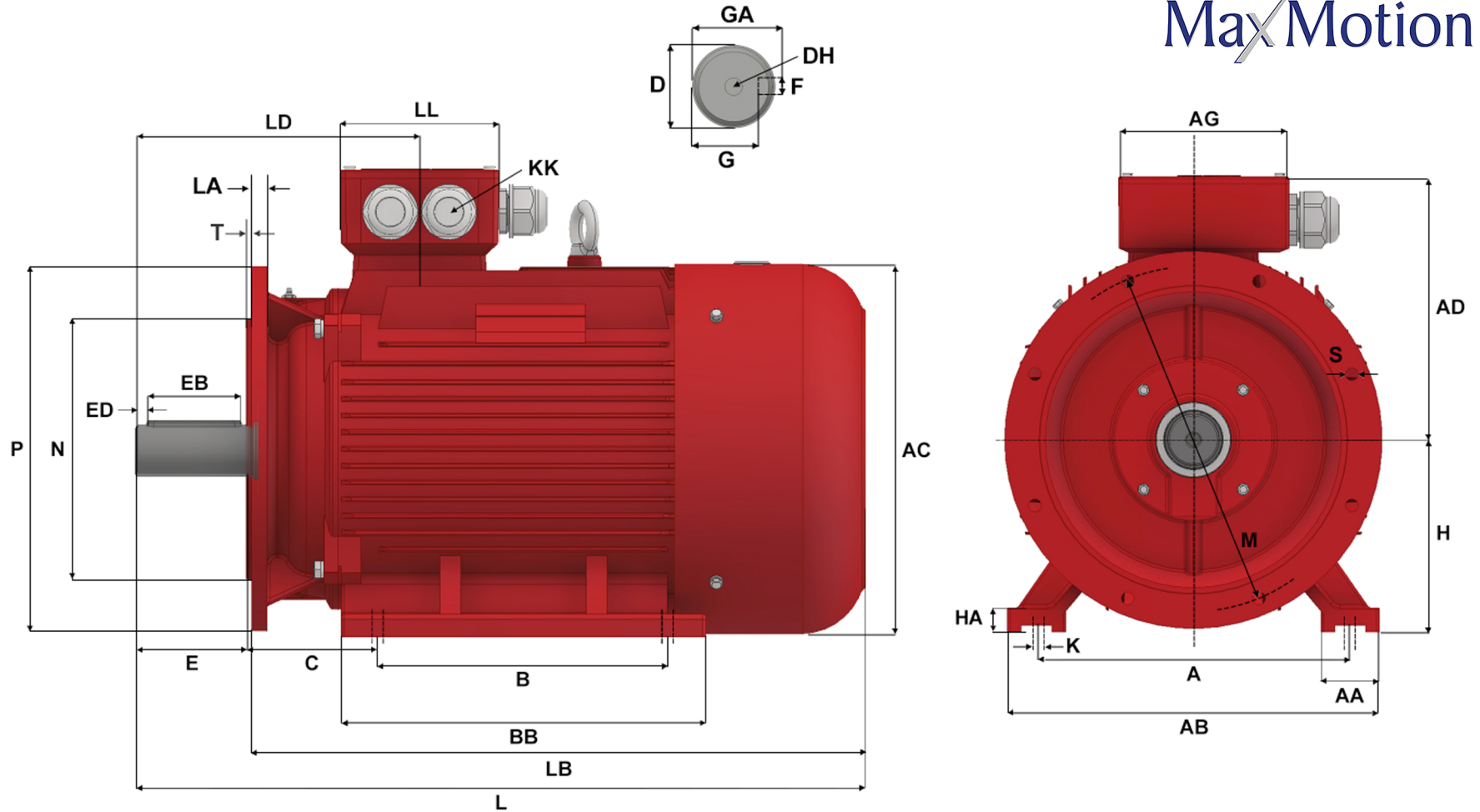

|  |           |        |                     |     |      |     |      |          |           |                |     |     |
|--|-----------|--------|---------------------|-----|------|-----|------|----------|-----------|----------------|-----|-----|
| Version: 2JLEM   |           |        | Revised: 21-07-2021 |     |      | HP  | RPM  | FRAME    | ENCLOSURE | IJC315L1-4-B35 |     |     |
| Customer is responsible in determining that Max Motion product will fit/perform suitably in the intended application |           |        |                     |     |      | 200 | 1785 | 315L     | TEFC      |                |     |     |
| A  | B         | C      | D                   | E   | F    | G   | H    | K        | L         | M              | N   | P   |
| 508  | 508       | 216    | 80                  | 170 | 22   | 71  | 315  | 4 - Ø 28 | 1318      | 600            | 550 | 660 |
| S  | T         | AA     | AB                  | AC  | AD   | AG  | BA   | BB       | DH        | EB             | ED  | GA  |
| 8 - Ø 24   | 6         | 120    | 628                 | 620 | 527  | 320 | 0    | 680      | M20 X 42  | 160            | 5   | 85  |
| HA   | KK (1)    | KK (2) | KK (3)              | LA  | LB   | LD  | LL   |          |           |                |     |     |
| 45   | M63 X 1.5 | 2" NPT | M16 X 1.5           | 22  | 1148 | 427 | 280  |          |           |                |     |     |

## METRIC IE1 & IE3 ALUMINUM & CAST IRON MOTORS

IEC DESIGN, WITH NEMA B TORQUE CURVES

TEFC TOTALLY ENCLOSED FAN COOLED

# MaxMotion

### Applications:

General purpose use on conveyors, compressors, pumps, fans, blowers and other industrial and process machinery. Motors can be locally modified to match special electrical designs such as 2 speed or any non-standard connection requirements. Special mechanical requirements such as shafts or flanges can be fabricated in 3-4 days.



### Features:

**Design** - IEC Standard 60034-1 for energy efficiency, rotating electrical machines part 2-1, compliant with efficiency standards covered by NEMA, CSA, CEMEP, COPANT, AS, NZS, JIS and GB.

**Agency Listings and Standard** - IEC, IEEE, CSA, CSAus, CE, NEMA, DOE, NRCan

**Service Factor** - 1.15 @ 60Hz and 1.0 @ 50Hz without derating power

**Electrical Supply - At 60Hz, standard voltages are:** 230 / 460 VAC: Fractional to 30HP, 460 / 796 VAC: 30HP to 300HP, 333 / 575 VAC: Fractional to 5.5HP, 575 / 990 VAC: 5.5HP to 300HP

**At 50Hz, standard voltages are:** 190 -220 / 380 - 415 VAC: Fractional to 30HP,

380 - 415 / 660 - 725 VAC: 30HP to 300HP

\*Custom voltages available on request i.e. 690V

**Windings** - Highest quality Enamel coated magnet wire. VPI with 2 stage dip and bake.

**Insulation** - Non hygroscopic Class H with Class B temperature rise

**Voltage and Frequency Variation** -  $\pm 10\%$  on 2 rated voltage points,  $\pm 5\%$  on frequency per regulation en 60204-1

**Bearings** - SKF single row deep groove ball bearings, frame sizes 132+ have re-greasing capabilities.

\*Special bearings are available on request.

**Earthing Terminals** - 1 in the terminal box and 1 on body of the motor.

**Bearing Lubricant** - For regreasable bearings, our standard is Polyrex EM (- 29°C to 177°C temperature range)

**Enclosure Protection** - Standard is IP55, others such as IP56, IP65 available on request

**Frame Construction** - Frames 56-160 are pressured die cast aluminum with base that can be removed/applied to accommodate F0, F1, F2 terminal box positions. Frames 180-355 are cast iron construction with F0 terminal box position.

**Conduit Box** - Large square cast aluminum terminal box designed to meet NEC space requirements. Can be rotated in 90 degree increments. Equipped with both NPT and PG plugs. Wiring diagram is embossed on the back of the cover. Inside you will find clearly marked stud type terminal blocks and leads identified in IEC format. Frames 132+ come equipped with extra gland for PTC connection.

**Inverter Duty** - Suitable for Inverter Duty applications, at all voltages for speed ranges of 10:1 constant torque and 20:1 variable torque. Meets NEMA MG-1 Part 31.4.4.2 criteria.

**Nameplate** - Oversized painted aluminum nameplate with 60Hz and 50Hz performance specifications along with multiple approval ratings.

**Drain Hole** - Cast iron frames, located in center bottom of casting.

**Fan Cover** - Rolled steel on all frame sizes, cast iron available on request

**Warranty** - 3 years from the date of manufacture



| HP   | KW      | FL RPM | VOLTS   | FRAME | CAT NO.         | CONSTRUCTION | NOM EFF.    | F.L. AMPS | WT (lbs) | DE BRG    | ODE BRG   | "L" Dimension (Inch) |
|------|---------|--------|---------|-------|-----------------|--------------|-------------|-----------|----------|-----------|-----------|----------------------|
| 0.13 | 0.09    | 1590   | 230/460 | 56    | IJA562-4-24     | Aluminum     | 54          | .69/.34   | 7.7      | 6201ZZ-C3 | 6201ZZ-C3 | 198.5                |
|      |         | 1590   | 333/575 | 56    | IJA562-4-35     | Aluminum     | 54          | .47/.27   | 7.7      | 6201ZZ-C3 | 6201ZZ-C3 | 198.5                |
|      |         | 1020   | 333/575 | 63    | IJA631-6-35     | Aluminum     | 44          | .61/.35   | 9.9      | 6201ZZ-C3 | 6201ZZ-C3 | 217                  |
| 0.17 | 0.12    | 3240   | 230/460 | 56    | IJA562-2-24     | Aluminum     | 64          | .65/.33   | 7.7      | 6201ZZ-C3 | 6201ZZ-C3 | 198.5                |
|      |         | 3240   | 333/575 | 56    | IJA562-2-35     | Aluminum     | 64          | .45/.26   | 7.7      | 6201ZZ-C3 | 6201ZZ-C3 | 198.5                |
|      |         | 1630   | 230/460 | 63    | IJA631-4-24     | Aluminum     | 62          | .76/.38   | 8.6      | 6201ZZ-C3 | 6201ZZ-C3 | 217                  |
|      |         | 1630   | 333/575 | 63    | IJA631-4-35     | Aluminum     | 62          | .53/.31   | 8.6      | 6201ZZ-C3 | 6201ZZ-C3 | 217                  |
|      |         | 1020   | 333/575 | 63    | IJA632-6-35     | Aluminum     | 48          | .72/.42   | 11       | 6201ZZ-C3 | 6201ZZ-C3 | 217                  |
| 0.25 | 0.19    | 3320   | 230/460 | 63    | IJA631-2-24     | Aluminum     | 63          | .92/.46   | 9.46     | 6201ZZ-C3 | 6201ZZ-C3 | 217                  |
|      |         | 3320   | 333/575 | 63    | IJA631-2-35     | Aluminum     | 63          | .61/.35   | 9.46     | 6201ZZ-C3 | 6201ZZ-C3 | 217                  |
|      |         | 1570   | 230/460 | 63    | IJA632-4-24     | Aluminum     | 66          | .94/.47   | 8.8      | 6201ZZ-C3 | 6201ZZ-C3 | 217                  |
|      |         | 1570   | 333/575 | 63    | IJA632-4-35     | Aluminum     | 66          | .65/.38   | 8.8      | 6201ZZ-C3 | 6201ZZ-C3 | 217                  |
|      |         | 1020   | 230/460 | 71    | IJA711-6-24     | Aluminum     | 52.5        | 1.3/.65   | 15.4     | 6202ZZ-C3 | 6202ZZ-C3 | 245                  |
|      |         | 1020   | 333/575 | 71    | IJA711-6-35     | Aluminum     | 52.5        | .90/.52   | 15.4     | 6202ZZ-C3 | 6202ZZ-C3 | 245                  |
| 0.33 | 0.25    | 3260   | 230/460 | 63    | IJA632-2-24     | Aluminum     | 64          | 1.21/.61  | 8.8      | 6201ZZ-C3 | 6201ZZ-C3 | 217                  |
|      |         | 3260   | 333/575 | 63    | IJA632-2-35     | Aluminum     | 64          | .84/.48   | 8.8      | 6201ZZ-C3 | 6201ZZ-C3 | 217                  |
|      |         | 1595   | 230/460 | 63    | IJA633-4-24     | Aluminum     | 68          | 1.25/.62  | 11       | 6201ZZ-C3 | 6201ZZ-C3 | 217                  |
|      |         | 1595   | 333/575 | 63    | IJA633-4-35     | Aluminum     | 68          | .86/.50   | 11       | 6201ZZ-C3 | 6201ZZ-C3 | 217                  |
|      |         | 1595   | 230/460 | 71    | IJA711-4-24     | Aluminum     | 68          | 1.25/.62  | 11       | 6201ZZ-C3 | 6201ZZ-C3 | 245                  |
|      |         | 1595   | 333/575 | 71    | IJA711-4-35     | Aluminum     | 68          | .86/.50   | 11       | 6201ZZ-C3 | 6201ZZ-C3 | 245                  |
|      |         | 1020   | 230/460 | 71    | IJA712-6-24     | Aluminum     | 57.5        | 1.6/.80   | 15.4     | 6202ZZ-C3 | 6202ZZ-C3 | 245                  |
|      |         | 1020   | 333/575 | 71    | IJA712-6-35     | Aluminum     | 57.5        | 1.11/.64  | 15.4     | 6202ZZ-C3 | 6202ZZ-C3 | 245                  |
|      |         | 0.5    | 0.37    | 3285  | 230/460         | 63           | IJA633-2-24 | Aluminum  | 70       | 1.64/.82  | 11        | 6201ZZ-C3            |
| 3285 | 333/575 |        |         | 63    | IJA633-2-35     | Aluminum     | 70          | 1.13/.66  | 11       | 6201ZZ-C3 | 6201ZZ-C3 | 217                  |
| 3285 | 230/460 |        |         | 71    | IJA711-2-24     | Aluminum     | 70          | 1.64/.82  | 11       | 6202ZZ-C3 | 6202ZZ-C3 | 245                  |
| 3285 | 333/575 |        |         | 71    | IJA711-2-35     | Aluminum     | 70          | 1.13/.66  | 11       | 6202ZZ-C3 | 6202ZZ-C3 | 245                  |
| 1595 | 230/460 |        |         | 71    | IJA712-4-24     | Aluminum     | 70          | 1.77/.88  | 12.1     | 6202ZZ-C3 | 6202ZZ-C3 | 245                  |
| 1595 | 333/575 |        |         | 71    | IJA712-4-35     | Aluminum     | 70          | 1.22/.71  | 12.1     | 6202ZZ-C3 | 6202ZZ-C3 | 245                  |
| 1060 | 230/460 |        |         | 80    | IJA801-6-24     | Aluminum     | 62          | 2.14/1.04 | 20.24    | 6204ZZ-C3 | 6204ZZ-C3 | 286                  |
| 1060 | 333/575 |        |         | 80    | IJA801-6-35     | Aluminum     | 62          | 1.48/.86  | 20.24    | 6204ZZ-C3 | 6204ZZ-C3 | 286                  |
| 0.75 | 0.56    | 3285   | 230/460 | 71    | IJA712-2-24     | Aluminum     | 72          | 2.34/1.17 | 13.2     | 6202ZZ-C3 | 6202ZZ-C3 | 245                  |
|      |         | 3285   | 333/575 | 71    | IJA712-2-35     | Aluminum     | 72          | 1.62/.94  | 13.2     | 6202ZZ-C3 | 6202ZZ-C3 | 245                  |
|      |         | 1665   | 230/460 | 71    | IJA713-4-24     | Aluminum     | 74          | 2.49/1.24 | 16.5     | 6202ZZ-C3 | 6202ZZ-C3 | 245                  |
|      |         | 1665   | 333/575 | 71    | IJA713-4-35     | Aluminum     | 74          | 1.72/1    | 16.4     | 6202ZZ-C3 | 6202ZZ-C3 | 245                  |
|      |         | 1680   | 230/460 | 80    | IJA2801-4-24    | Aluminum     | 81.1        | 2.27/1.13 | 20       | 6204ZZ-C3 | 6204ZZ-C3 | 285                  |
|      |         | 1680   | 333/575 | 80    | IJA2801-4-35    | Aluminum     | 81.1        | 1.56/0.90 | 20       | 6204ZZ-C3 | 6204ZZ-C3 | 285                  |
|      |         | 1060   | 230/460 | 80    | IJA2802-6-24    | Aluminum     | 72          | 2.91/1.45 | 22       | 6204ZZ-C3 | 6204ZZ-C3 | 285                  |
|      |         | 1060   | 333/575 | 80    | IJA2802-6-35    | Aluminum     | 72          | 2.01/1.16 | 22       | 6204ZZ-C3 | 6204ZZ-C3 | 285                  |
| 1    | 0.75    | 3455   | 230/460 | 71    | IJA713-2-24     | Aluminum     | 77          | 2.98/1.49 | 16.5     | 6202ZZ-C3 | 6202ZZ-C3 | 245                  |
|      |         | 3455   | 333/575 | 71    | IJA713-2-35     | Aluminum     | 77          | 2.06/1.19 | 16.5     | 6202ZZ-C3 | 6202ZZ-C3 | 245                  |
|      |         | 3455   | 230/460 | 80    | IJA2801-2-24    | Aluminum     | 77          | 2.98/1.49 | 19.8     | 6204ZZ-C3 | 6204ZZ-C3 | 285                  |
|      |         | 3455   | 333/575 | 80    | IJA2801-2-35    | Aluminum     | 77          | 2.06/1.19 | 19.8     | 6204ZZ-C3 | 6204ZZ-C3 | 285                  |
|      |         | 1704   | 230/460 | 80    | IJA2802-4-24    | Aluminum     | 83.5        | 3.01/1.50 | 24.4     | 6204ZZ-C3 | 6204ZZ-C3 | 285                  |
|      |         | 1704   | 333/575 | 80    | IJA2802-4-35    | Aluminum     | 83.5        | 2.07/1.20 | 24.4     | 6204ZZ-C3 | 6204ZZ-C3 | 285                  |
|      |         | 1120   | 230/460 | 90    | IJA2905-6-24    | Aluminum     | 82.5        | 3.21/1.61 | 35.2     | 6205ZZ-C3 | 6205ZZ-C3 | 315                  |
|      |         | 1120   | 333/575 | 90    | IJA2905-6-35    | Aluminum     | 82.5        | 2.22/1.29 | 35.2     | 6205ZZ-C3 | 6205ZZ-C3 | 315                  |
| 1.5  | 1.12    | 3455   | 230/460 | 80    | IJA2802-2-24    | Aluminum     | 84          | 3.96/1.98 | 19.3     | 6204ZZ-C3 | 6204ZZ-C3 | 285                  |
|      |         | 3455   | 333/575 | 80    | IJA2802-2-35    | Aluminum     | 84          | 2.74/1.58 | 19.3     | 6204ZZ-C3 | 6204ZZ-C3 | 285                  |
|      |         | 1665   | 230/460 | 80    | IJA803-4-24-IE3 | Aluminum     | 79          | 4.54/2.27 | 23.1     | 6204ZZ-C3 | 6204ZZ-C3 | 300                  |
|      |         | 1665   | 333/575 | 80    | IJA803-4-35-IE3 | Aluminum     | 79          | 3.14/1.82 | 23.1     | 6204ZZ-C3 | 6204ZZ-C3 | 300                  |
|      |         | 1734   | 230/460 | 90    | IJA2905-4-24    | Aluminum     | 86.5        | 4.2/2.1   | 35.2     | 6205ZZ-C3 | 6205ZZ-C3 | 315                  |
|      |         | 1734   | 333/575 | 90    | IJA2905-4-35    | Aluminum     | 86.5        | 2.90/1.68 | 35.2     | 6205ZZ-C3 | 6205ZZ-C3 | 315                  |
|      |         | 1134   | 230/460 | 90    | IJA290L-6-24    | Aluminum     | 87.5        | 4.32/2.16 | 49.2     | 6205ZZ-C3 | 6205ZZ-C3 | 340                  |
| 2    | 1.5     | 1134   | 333/575 | 90    | IJA290L-6-35    | Aluminum     | 87.5        | 2.99/1.73 | 49.2     | 6205ZZ-C3 | 6205ZZ-C3 | 340                  |
|      |         | 3470   | 230/460 | 80    | IJA803-2-24-IE3 | Aluminum     | 85.5        | 5.24/2.62 | 26.4     | 6204ZZ-C3 | 6204ZZ-C3 | 300                  |
|      |         | 3470   | 333/575 | 80    | IJA803-2-35-IE3 | Aluminum     | 85.5        | 3.62/2.10 | 26.4     | 6204ZZ-C3 | 6204ZZ-C3 | 300                  |
|      |         | 3474   | 230/460 | 90    | IJA2905-2-24    | Aluminum     | 85.5        | 5.24/2.62 | 29.7     | 6205ZZ-C3 | 6205ZZ-C3 | 315                  |
|      |         | 3474   | 333/575 | 90    | IJA2905-2-35    | Aluminum     | 85.5        | 3.62/2.10 | 29.7     | 6205ZZ-C3 | 6205ZZ-C3 | 315                  |
|      |         | 1734   | 230/460 | 90    | IJA290L-4-24    | Aluminum     | 86.5        | 5.65/2.83 | 39.6     | 6205ZZ-C3 | 6205ZZ-C3 | 340                  |
|      |         | 1734   | 333/575 | 90    | IJA290L-4-35    | Aluminum     | 86.5        | 3.90/2.26 | 39.6     | 6205ZZ-C3 | 6205ZZ-C3 | 340                  |
|      |         | 1139   | 230/460 | 100   | IJA2100L-6-24   | Aluminum     | 88.5        | 5.80/2.90 | 73.7     | 6206ZZ-C3 | 6206ZZ-C3 | 380                  |
| 2.4  | 1.79    | 1139   | 333/575 | 100   | IJA2100L-6-35   | Aluminum     | 88.5        | 4.01/2.32 | 73.7     | 6206ZZ-C3 | 6206ZZ-C3 | 380                  |
|      |         | 1730   | 230/460 | 90    | IJA90L2-4-24    | Aluminum     | 86.5        | 6.70/3.35 | 45.1     | 6205ZZ-C3 | 6205ZZ-C3 | 345                  |
| 3    | 2.24    | 1730   | 333/575 | 90    | IJA90L2-4-35    | Aluminum     | 86.5        | 4.63/2.68 | 45.1     | 6205ZZ-C3 | 6205ZZ-C3 | 345                  |
|      |         | 3474   | 230/460 | 90    | IJA290L-2-24    | Aluminum     | 86.5        | 7.51/3.76 | 37.4     | 6205ZZ-C3 | 6205ZZ-C3 | 340                  |
|      |         | 3474   | 333/575 | 90    | IJA290L-2-35    | Aluminum     | 86.5        | 5.19/3.01 | 37.4     | 6205ZZ-C3 | 6205ZZ-C3 | 340                  |
|      |         | 1740   | 230/460 | 100   | IJA2100L1-4-24  | Aluminum     | 89.5        | 7.60/3.80 | 55       | 6206ZZ-C3 | 6206ZZ-C3 | 380                  |
|      |         | 1740   | 333/575 | 100   | IJA2100L1-4-35  | Aluminum     | 89.5        | 5.25/3.04 | 55       | 6206ZZ-C3 | 6206ZZ-C3 | 380                  |
|      |         | 1145   | 230/460 | 112   | IJA2112M-6-46   | Aluminum     | 89.5        | 8.30/4.20 | 66       | 6306ZZ-C3 | 6306ZZ-C3 | 401                  |
|      |         | 1145   | 575/990 | 112   | IJA2112M-6-59   | Aluminum     | 89.5        | 5.80/3.36 | 66       | 6306ZZ-C3 | 6306ZZ-C3 | 401                  |

| HP   | KW      | FL RPM | VOLTS   | FRAME | CAT NO.        | CONSTRUCTION | NOM EFF.      | F.L. AMPS   | WT (Lbs) | DE BRG      | ODE BRG   | "L" Dimension (Inch) |         |     |
|------|---------|--------|---------|-------|----------------|--------------|---------------|-------------|----------|-------------|-----------|----------------------|---------|-----|
| 4    | 2.98    | 3470   | 230/460 | 90    | IJA90L2-2-24   | Aluminum     | 88.5          | 9.78/4.89   | 42.9     | 6206ZZ-C3   | 6206ZZ-C3 | 345                  |         |     |
|      |         | 3470   | 333/575 | 90    | IJA90L2-2-35   | Aluminum     | 88.5          | 6.76/3.91   | 42.9     | 6206ZZ-C3   | 6206ZZ-C3 | 345                  |         |     |
|      |         | 3474   | 230/460 | 100   | IJA2100L-2-24  | Aluminum     | 88.5          | 9.80/4.90   | 50.6     | 6206ZZ-C3   | 6206ZZ-C3 | 380                  |         |     |
|      |         | 3474   | 333/575 | 100   | IJA2100L-2-35  | Aluminum     | 88.5          | 6.77/3.92   | 50.6     | 6206ZZ-C3   | 6206ZZ-C3 | 380                  |         |     |
|      |         | 1740   | 230/460 | 100   | IJA2100L2-4-24 | Aluminum     | 89.5          | 10.30/5.10  | 67.1     | 6206ZZ-C3   | 6206ZZ-C3 | 380                  |         |     |
|      |         | 1740   | 333/575 | 100   | IJA2100L2-4-35 | Aluminum     | 89.5          | 7.05/4.08   | 67.1     | 6206ZZ-C3   | 6206ZZ-C3 | 380                  |         |     |
|      |         | 1160   | 230/460 | 132   | IJA132S-6-46   | Aluminum     | 89.5          | 11.40/5.69  | 91.3     | 6308ZZ-C3   | 6308ZZ-C3 | 445                  |         |     |
|      |         | 1160   | 575/990 | 132   | IJA132S-6-59   | Aluminum     | 89.5          | 4.55/2.64   | 91.3     | 6308ZZ-C3   | 6308ZZ-C3 | 445                  |         |     |
| 5.5  | 4.1     | 3485   | 230/460 | 100   | IJA100L2-2-24  | Aluminum     | 88.5          | 12.90/6.45  | 63.8     | 6306ZZ-C3   | 6306ZZ-C3 | 405                  |         |     |
|      |         | 3485   | 575/990 | 100   | IJA100L2-2-35  | Aluminum     | 88.5          | 8.90/5.16   | 63.8     | 6306ZZ-C3   | 6306ZZ-C3 | 405                  |         |     |
|      |         | 3485   | 230/460 | 112   | IJA2112M-2-46  | Aluminum     | 88.5          | 12.90/6.40  | 63.9     | 6306ZZ-C3   | 6306ZZ-C3 | 401                  |         |     |
|      |         | 3485   | 575/990 | 112   | IJA2112M-2-59  | Aluminum     | 88.5          | 8.84/5.12   | 63.9     | 6306ZZ-C3   | 6306ZZ-C3 | 401                  |         |     |
|      |         | 1725   | 230/460 | 112   | IJA2112M-4-46  | Aluminum     | 89.5          | 13.70/6.80  | 82.5     | 6306ZZ-C3   | 6306ZZ-C3 | 401                  |         |     |
|      |         | 1725   | 575/990 | 112   | IJA2112M-4-59  | Aluminum     | 89.5          | 9.39/5.44   | 82.5     | 6306ZZ-C3   | 6306ZZ-C3 | 401                  |         |     |
|      |         | 1160   | 230/460 | 132   | IJA132M1-6-46  | Aluminum     | 89.5          | 15.20/7.58  | 108.9    | 6308ZZ-C3   | 6308ZZ-C3 | 485                  |         |     |
|      |         | 1160   | 575/990 | 132   | IJA132M1-6-59  | Aluminum     | 89.5          | 6.10/3.52   | 108.9    | 6308ZZ-C3   | 6308ZZ-C3 | 485                  |         |     |
| 7.5  | 5.6     | 3515   | 230/460 | 112   | IJA2112M2-2-46 | Aluminum     | 89.5          | 17.50/8.76  | 79.2     | 6306ZZ-C3   | 6306ZZ-C3 | 401                  |         |     |
|      |         | 3515   | 575/990 | 112   | IJA2112M2-2-59 | Aluminum     | 89.5          | 12.10/7.01  | 79.2     | 6306ZZ-C3   | 6306ZZ-C3 | 401                  |         |     |
|      |         | 3515   | 230/460 | 132   | IJA132S1-2-46  | Aluminum     | 89.5          | 17.50/8.76  | 94.6     | 6308ZZ-C3   | 6308ZZ-C3 | 445                  |         |     |
|      |         | 3515   | 575/990 | 132   | IJA132S1-2-59  | Aluminum     | 89.5          | 7.01/4.07   | 94.6     | 6308ZZ-C3   | 6308ZZ-C3 | 445                  |         |     |
|      |         | 1750   | 230/460 | 132   | IJA132S-4-46   | Aluminum     | 91.7          | 18.10/9.07  | 107.8    | 6308ZZ-C3   | 6308ZZ-C3 | 445                  |         |     |
|      |         | 1750   | 575/990 | 132   | IJA132S-4-59   | Aluminum     | 91.7          | 7.26/4.21   | 107.8    | 6308ZZ-C3   | 6308ZZ-C3 | 445                  |         |     |
|      |         | 1160   | 230/460 | 132   | IJA132M2-6-46  | Aluminum     | 91            | 20.20/10.10 | 133      | 6308ZZ-C3   | 6308ZZ-C3 | 485                  |         |     |
|      |         | 1160   | 575/990 | 132   | IJA132M2-6-59  | Aluminum     | 91            | 8.09/4.70   | 133      | 6308ZZ-C3   | 6308ZZ-C3 | 485                  |         |     |
| 10   | 7.46    | 3515   | 230/460 | 112   | IJA112M3-2-46  | Aluminum     | 90.2          | 23.7/11.9   | 84.7     | 6308ZZ-C3   | 6308ZZ-C3 | 400                  |         |     |
|      |         | 3515   | 575/990 | 112   | IJA112M3-2-59  | Aluminum     | 90.2          | 9.49/5.51   | 84.7     | 6308ZZ-C3   | 6308ZZ-C3 | 400                  |         |     |
|      |         | 3515   | 230/460 | 132   | IJA132S2-2-46  | Aluminum     | 90.2          | 23.70/11.90 | 105.6    | 6308ZZ-C3   | 6308ZZ-C3 | 445                  |         |     |
|      |         | 3515   | 575/990 | 132   | IJA132S2-2-59  | Aluminum     | 90.2          | 9.49/5.51   | 105.6    | 6308ZZ-C3   | 6308ZZ-C3 | 445                  |         |     |
|      |         | 1750   | 230/460 | 132   | IJA132M-4-46   | Aluminum     | 91.7          | 24.40/12.20 | 128.7    | 6308ZZ-C3   | 6308ZZ-C3 | 485                  |         |     |
|      |         | 1750   | 575/990 | 132   | IJA132M-4-59   | Aluminum     | 91.7          | 9.78/5.68   | 128.7    | 6308ZZ-C3   | 6308ZZ-C3 | 485                  |         |     |
|      |         | 1160   | 230/460 | 160   | IJA160M-6-46   | Aluminum     | 91            | 26.20/13.10 | 184.8    | 6309-C3     | 6309-C3   | 615                  |         |     |
|      |         | 1160   | 575/990 | 160   | IJA160M-6-59   | Aluminum     | 91            | 10.50/6.08  | 184.8    | 6309-C3     | 6309-C3   | 615                  |         |     |
| 12.4 | 9.25    | 3530   | 230/460 | 132   | IJA132M1-2-46  | Aluminum     | 90.2          | 28.90/14.50 | 125.4    | 6308ZZ-C3   | 6308ZZ-C3 | 485                  |         |     |
|      |         | 3530   | 575/990 | 132   | IJA132M1-2-59  | Aluminum     | 90.2          | 11.60/6.72  | 125.4    | 6308ZZ-C3   | 6308ZZ-C3 | 485                  |         |     |
|      |         | 1750   | 230/460 | 132   | IJA132M1-4-46  | Aluminum     | 90.4          | 30.60/15.30 | 158.4    | 6308ZZ-C3   | 6308ZZ-C3 | 485                  |         |     |
|      |         | 1750   | 575/990 | 132   | IJA132M1-4-59  | Aluminum     | 90.4          | 12.20/7.10  | 158.4    | 6308ZZ-C3   | 6308ZZ-C3 | 485                  |         |     |
| 15   | 11.19   | 3530   | 230/460 | 132   | IJA132M2-2-46  | Aluminum     | 91            | 34.10/17    | 129.8    | 6308ZZ-C3   | 6308ZZ-C3 | 485                  |         |     |
|      |         | 3530   | 575/990 | 132   | IJA132M2-2-59  | Aluminum     | 91            | 13.60/7.92  | 129.8    | 6308ZZ-C3   | 6308ZZ-C3 | 485                  |         |     |
|      |         | 3530   | 230/460 | 160   | IJA160M1-2-46  | Aluminum     | 91            | 34.10/17    | 185.9    | 6309-C3     | 6309-C3   | 615                  |         |     |
|      |         | 3530   | 575/990 | 160   | IJA160M1-2-59  | Aluminum     | 91            | 13.60/7.92  | 185.9    | 6309-C3     | 6309-C3   | 615                  |         |     |
|      |         | 1755   | 230/460 | 160   | IJA160M-4-46   | Aluminum     | 92.4          | 35.20/17.60 | 221.1    | 6309-C3     | 6309-C3   | 615                  |         |     |
|      |         | 1755   | 575/990 | 160   | IJA160M-4-59   | Aluminum     | 92.4          | 14.10/8.17  | 221.1    | 6309-C3     | 6309-C3   | 615                  |         |     |
|      |         | 1160   | 230/460 | 160   | IJA160L-6-46   | Aluminum     | 91.7          | 37.60/18.80 | 236.5    | 6309-C3     | 6309-C3   | 660                  |         |     |
|      |         | 1160   | 575/990 | 160   | IJA160L-6-59   | Aluminum     | 91.7          | 15.04/8.71  | 236.5    | 6309-C3     | 6309-C3   | 660                  |         |     |
| 20   | 14.92   | 3530   | 230/460 | 132   | IJA132M3-2-46  | Aluminum     | 91            | 46.5/23.2   | 143      | 6308-C3     | 6308-C3   | 485                  |         |     |
|      |         | 3530   | 575/990 | 132   | IJA132M3-2-59  | Aluminum     | 91            | 18.6/10.8   | 143      | 6309-C3     | 6309-C3   | 485                  |         |     |
|      |         | 3530   | 230/460 | 160   | IJA160M2-2-46  | Aluminum     | 91            | 46.50/23.20 | 210.1    | 6309-C3     | 6309-C3   | 615                  |         |     |
|      |         | 3530   | 575/990 | 160   | IJA160M2-2-59  | Aluminum     | 91            | 18.60/10.80 | 210.1    | 6309-C3     | 6309-C3   | 615                  |         |     |
|      |         | 1755   | 230/460 | 160   | IJA160L-4-46   | Aluminum     | 93            | 47.10/23.50 | 237.6    | 6309-C3     | 6309-C3   | 660                  |         |     |
|      |         | 1755   | 575/990 | 160   | IJA160L-4-59   | Aluminum     | 93            | 18.80/10.90 | 237.6    | 6309-C3     | 6309-C3   | 660                  |         |     |
|      |         | 1170   | 230/460 | 180   | IJC180L-6-46   | Cast Iron    | 91.7          | 50.70/25.30 | 430      | 6311-C3     | 6311-C3   | 690                  |         |     |
|      |         | 1170   | 575/990 | 180   | IJC180L-6-59   | Cast Iron    | 91.7          | 20.24/11.73 | 430      | 6311-C3     | 6311-C3   | 690                  |         |     |
| 25   | 18.65   | 3525   | 230/460 | 160   | IJA160L-2-46   | Cast Iron    | 91.7          | 56.90/28.50 | 238.7    | 6309-C3     | 6309-C3   | 660                  |         |     |
|      |         | 3525   | 575/990 | 160   | IJA160L-2-59   | Cast Iron    | 91.7          | 22.80/13.20 | 238.7    | 6309-C3     | 6309-C3   | 660                  |         |     |
|      |         | 1760   | 230/460 | 180   | IJC180M-4-46   | Cast Iron    | 93.6          | 57.70/28.80 | 406      | 6311-C3     | 6311-C3   | 652                  |         |     |
|      |         | 1760   | 575/990 | 180   | IJC180M-4-59   | Cast Iron    | 93.6          | 23.10/13.40 | 406      | 6311-C3     | 6311-C3   | 652                  |         |     |
|      |         | 1175   | 460/796 | 200   | IJC200L1-6-47  | Cast Iron    | 93            | 30.80/17.80 | 507.8    | 6312-C3     | 6312-C3   | 746                  |         |     |
|      |         | 1175   | 575/990 | 200   | IJC200L1-6-59  | Cast Iron    | 93            | 24.64/14.30 | 507.8    | 6312-C3     | 6312-C3   | 746                  |         |     |
|      |         | 30     | 22.38   | 3545  | 230/460        | 160          | IJA160L2-2-46 | Cast Iron   | 91.7     | 67.70/33.80 | 245.3     | 6309-C3              | 6309-C3 | 660 |
|      |         |        |         | 3545  | 575/990        | 160          | IJA160L2-2-59 | Cast Iron   | 91.7     | 27.10/15.70 | 245.3     | 6309-C3              | 6309-C3 | 660 |
| 3545 | 230/460 |        |         | 180   | IJC180M-2-46   | Cast Iron    | 91.7          | 67.70/33.80 | 412.7    | 6311-C3     | 6311-C3   | 652                  |         |     |
| 3545 | 575/990 |        |         | 180   | IJC180M-2-59   | Cast Iron    | 91.7          | 27.10/15.70 | 412.7    | 6311-C3     | 6311-C3   | 652                  |         |     |
| 1760 | 230/460 |        |         | 180   | IJC180L-4-46   | Cast Iron    | 93.6          | 68.60/34.30 | 467      | 6311-C3     | 6311-C3   | 690                  |         |     |
| 1760 | 575/990 |        |         | 180   | IJC180L-4-59   | Cast Iron    | 93.6          | 27.40/15.90 | 467      | 6311-C3     | 6311-C3   | 690                  |         |     |
| 1175 | 460/796 |        |         | 200   | IJC200L2-6-47  | Cast Iron    | 93            | 36.70/21.20 | 358.8    | 6312-C3     | 6312-C3   | 746                  |         |     |
| 1175 | 575/990 |        |         | 200   | IJC200L2-6-59  | Cast Iron    | 93            | 29.36/26.10 | 358.8    | 6312-C3     | 6312-C3   | 746                  |         |     |
| 40   | 29.84   | 3550   | 460/796 | 200   | IJC200L1-2-47  | Cast Iron    | 92.4          | 45.80/26.50 | 550      | 6312-C3     | 6312-C3   | 746                  |         |     |
|      |         | 3550   | 575/990 | 200   | IJC200L1-2-59  | Cast Iron    | 92.4          | 36.60/21.30 | 550      | 6312-C3     | 6312-C3   | 746                  |         |     |
|      |         | 1770   | 460/796 | 200   | IJC200L-4-47   | Cast Iron    | 94.1          | 46.50/26.90 | 583      | 6312-C3     | 6312-C3   | 746                  |         |     |
|      |         | 1770   | 575/990 | 200   | IJC200L-4-59   | Cast Iron    | 94.1          | 37.20/21.60 | 583      | 6312-C3     | 6312-C3   | 746                  |         |     |
|      |         | 1175   | 460/796 | 225   | IJC225M-6-47   | Cast Iron    | 94.1          | 48.20/27.90 | 667      | 6313-C3     | 6313-C3   | 810                  |         |     |
|      |         | 1175   | 575/990 | 225   | IJC225M-6-59   | Cast Iron    | 94.1          | 38.56/22.40 | 667      | 6313-C3     | 6313-C3   | 810                  |         |     |







Our oversized aluminium nameplate allows for quick reference to both 60 and 50Hz performance values spread across a wide voltage range. Multiple approval ratings provides locally compliant motors ready for export to over 28 global regions. The Max Motion IEC line is designed to meet or exceed all IEC 34 and 72 electrical standards while satisfying NEMA MG1 Part 31.4.4.2 for VFD inverter fed applications.



Heat has long been the great adversary for motor longevity. We address this concern logically by the use of a class H insulation system throughout the motor windings and leads. All of our motors exceed the criteria critical for optimal operation in 10:1 Constant Torque and 20:1 Variable Torque applications. This hybrid platform meets both IEC Design N and NEMA Design B Torque characteristics.



A large, square, cast aluminium T-box has been designed to meet NEC space requirements. Equipped with NPT and PG plugs, it can be rotated in 90 degree increments and boasts a wiring diagram embossed on to the back of the cover. There are no plastic cost outs here! Inside are clearly marked, stud type terminal blocks and leads marked in the proper IEC format.



Knowing that over 57% of motor failures occur due to bearings, it's understood that bearings play an essential role in a motor's life cycle. This is why we use over-sized SKF Explorer Deep Groove Ball Bearings in our motors, as standard. We went the extra mile to include re-greasing capabilities from frame sizes 132 to 355. In conjunction with the Class H insulation system, you get a cool running motor which gives us the ability to offer our customers a full 3 year warranty.



Frame sizes 56 – 160 are of lightweight aluminium construction, with removable base and flexible multi-orientation capability (F1, F2, F3). With an ultra-smooth and elongated fin design, heat is dissipated quickly. Cast iron frames are available from sizes 180 – 500 and offers the same fin design as with aluminium units. Rolled steel fan covers are standard on all frames and special cast iron fan covers can be furnished upon request.



**MaxMotion**

**MEP INC**

Ontario, Western  
Canada, Newfound-  
land, Labrador and USA

2831 Bristol Circle Unit 3  
Oakville, ON L6H 6X5  
Tel: 905-829-1020  
Toll free: 877-812-7788  
Email: [information@mep.ca](mailto:information@mep.ca)

Quebec and Maritimes

10500 Boul. du Golf  
Anjou, QC H1J 2Y7  
Tel: 514-352-1229  
Toll free: 888-668-3877  
Email: [info@mep.ca](mailto:info@mep.ca)

